

Framework Napkins

by Heather Seth & Elise Lea for White Owl Textiles

Finished size: 19" x 19"



Indigo Lane - Page 2



Petal Whispers - Page 3



Paddle & Pine - Page 4



Botanical Sketchbook - Page 5

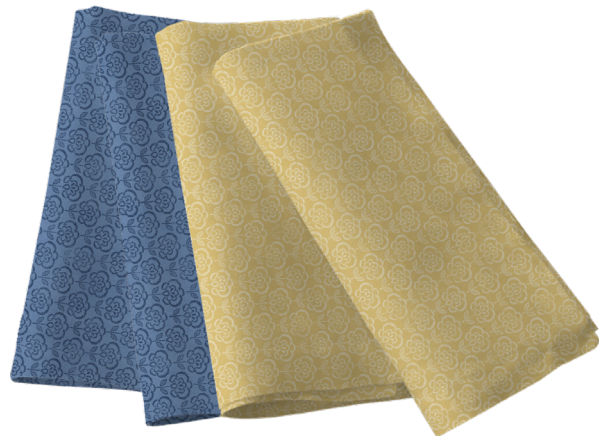

Rooster Reverie - Page 6

Fabric Guide

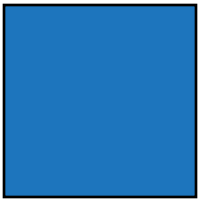

Napkins
5/8 yard

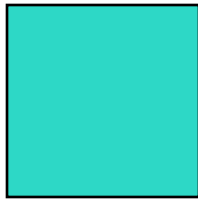

Napkins
5/8 yard

Each 5/8 yard makes 2
napkins.

Kindly note, our free patterns are not to be sold nor hosted on any other websites. We appreciate your understanding.

All seam allowances are 1/4" unless otherwise stated.
Press seams open unless otherwise stated.

WOF = Width of Fabric (selvage to selvage)
RST = Right Sides Together

Cutting Instructions

From each fabric	Cut two 20" squares
------------------	---------------------

Sewing Instructions

Step 1: Fold and press all edges 1/4" wrong sides together. Fold over another 1/4" and press again.

Step 2: Open the corners back up and trim along the line shown below, using your pressed lines as a guide.

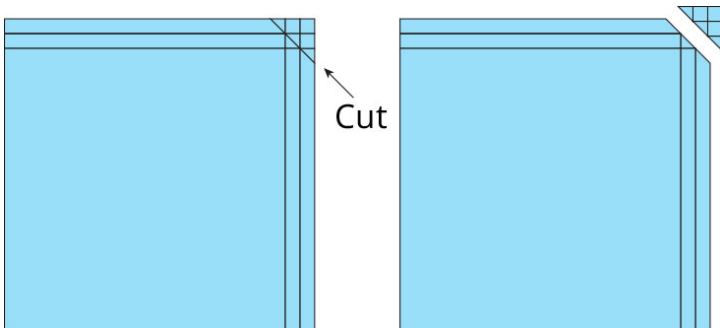

Step 3: Fold over and press the trimmed corner 1/4" wrong sides together.

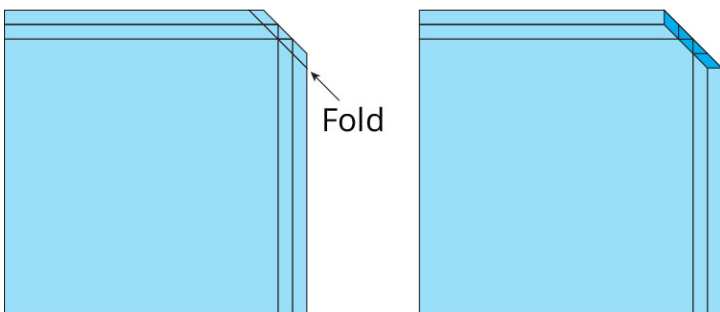

Step 4: Repeat Steps 2-3 for all 4 corners.

Step 5: Refold napkin along original 1/4" fold line and press. Refold along the second 1/4" fold line and press.

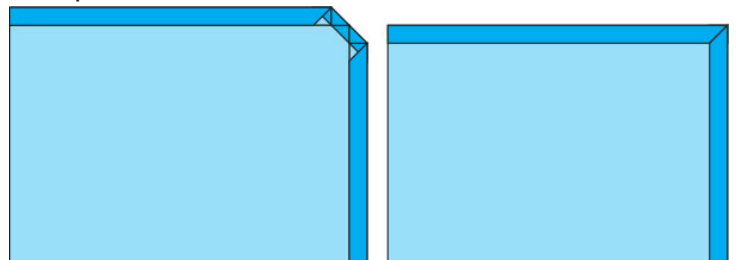

Step 6: Topstitch around the entire napkin, close to the edge of the hem.

Repeat to make desired number of napkins.

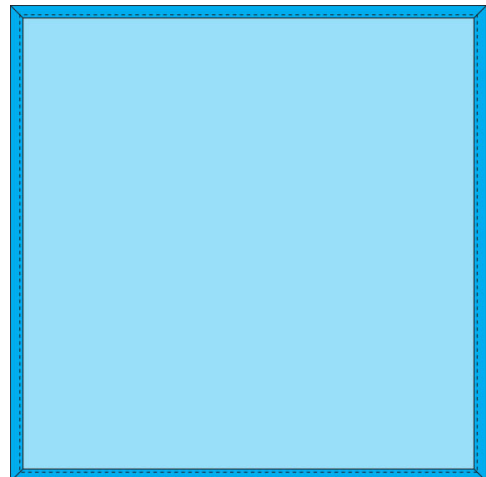

Woohoo! Your Napkins are now finished!

Indigo Lane



Fabric Guide



Napkins
W160-005-550
5/8 yard

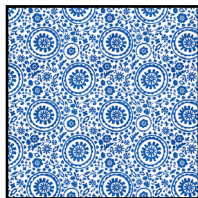

Napkins
W160-004-055
5/8 yard

Each 5/8 yard makes 2
napkins.

Petal Whispers



Fabric Guide

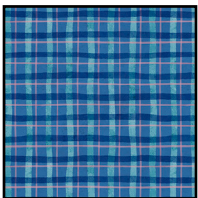

Napkins
W110-022-591
5/8 yard

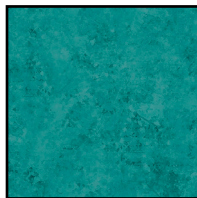

Napkins
W110-023-999
5/8 yard

Each 5/8 yard makes 2
napkins.

Paddle & Pine



Fabric Guide

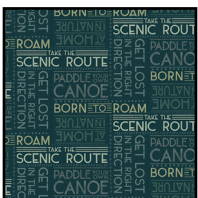

Napkins
W135-027-556
5/8 yard



Napkins
W135-025-660
5/8 yard

Each 5/8 yard makes 2 napkins.

Botanical Sketchbook



Fabric Guide



Napkins
W115-022-707
5/8 yard



Napkins
W115-018-070
5/8 yard

Each 5/8 yard makes 2
napkins.

Rooster Reverie

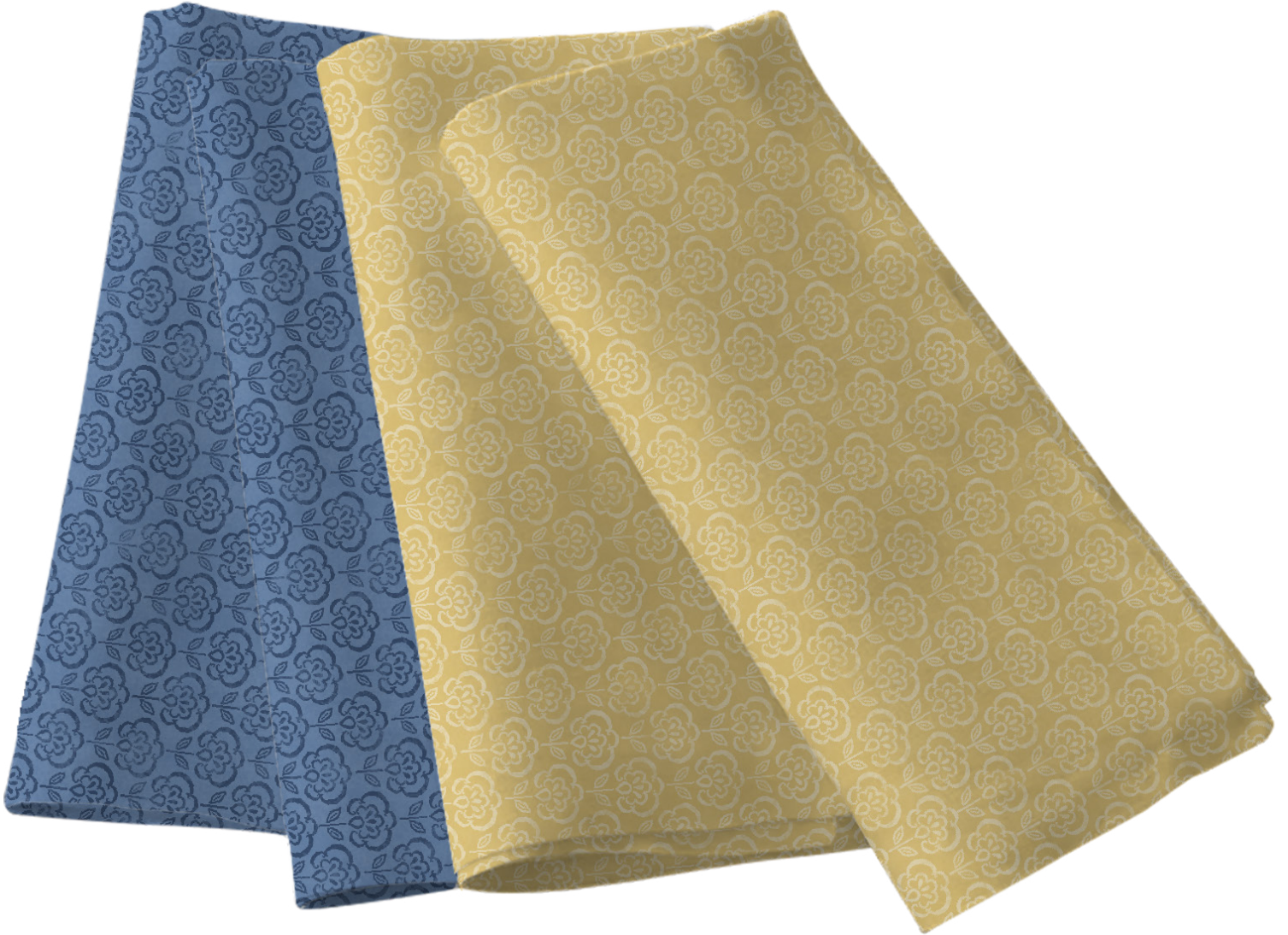

Fabric Guide

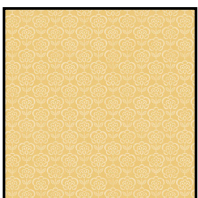

Napkins
W105-047-202
5/8 yard

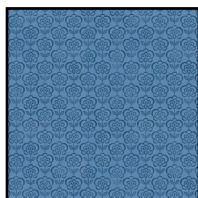

Napkins
W105-047-555
5/8 yard

Each 5/8 yard makes 2
napkins.